



CD988BT

BLUETOOTH / USB / SD / MP3 / CD / RADIO

Operation Instructions

Safety Information

Thank you for purchasing the player. Please read this manual carefully before operating and reserve it for future reference.

WARNING:

- To reduce the risk of fire or electric shock, DO NOT expose this product to rain or moisture.
- DO NOT open covers and do not repair yourself. Consult the dealer or an experienced technician for help.

PRECAUTIONS

- Use only in a 12-volt DC negative-ground electrical system.
- Disconnect the vehicle's negative battery terminal while mounting and connecting the unit.
- When replacing the fuse, be sure to use one with an identical amperage rating. Using a fuse with a higher amperage rating may cause serious damage to the unit.
- DO NOT attempt to disassemble the unit. Laser beams from the optical pick up are dangerous to the eyes.
- Make sure that pins or other foreign objects do not get inside the unit; they may cause malfunctions, or create safety hazards such as electrical shock or laser beam exposure.
- If you have parked the car for a long time in hot or cold weather, wait until the temperature in the car becomes normal

before operating the unit.

- Keep the volume at a level at which you can hear outside warning sounds (horns sirens, etc.).

DISC NOTES

- Playing a defective or dusty CD can cause dropouts in sound. Hold CDs as illustrated.
- Do not touch the unlabelled side.
- Do not attach any seal, label or data protection sheet to either side of a disc.
- Do not expose a CD to direct sunlight or excessive heat.
- Wipe a dirty CD from the center outward with a cleaning cloth.
- Never use solvents such as benzine or alcohol.
- This unit cannot play 3-inch (8cm) CDs. Never insert a 3-inch CD contained in the adapter or an irregularly shaped CD. The unit may not be able to eject it, resulting in a malfunction.

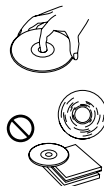

BEFORE OPERATION

- Do not raise the volume level too much, as this will block outside sounds, making driving dangerous.
- Stop the car before performing any complicated operation.

Contents

Safety Information	1
Panel Controls	2-3
Remote Control	4
General Operation	5
Radio	5-6
USB/SD/MMC Operation.....	7
MP3/WMA Playback.....	7-9
Bluetooth Operation.....	9-10
Menu Function.....	11
Electrical Connections	12
Installation Guide.....	13
Anti-Theft System	13-14
Troubleshooting.....	14
Specifications	15

* In addition to ordinary CDs, this unit can play back a CD-R/CD-RW/MP3/CD-TEXT.

Panel Controls

Press PWR button to turn on the unit.

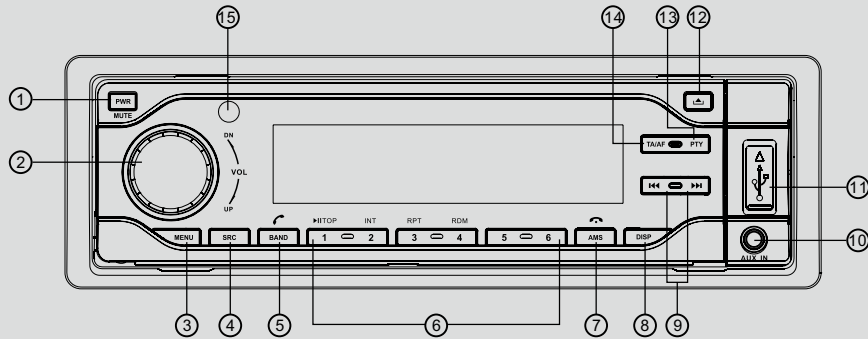

1. - Mute
- Press more than 2 seconds to power off.
2. - Rotate to adjust volume.
3. - Press to select VOLUME/BASS/TREBLE/BALANCE/FADER, rotate the knob to adjust.
- Long press to enter system menu.
4. - Radio
- Disc play (when disc is in)
- SD/MMC card (when SD/MMC inserted)
- USB-drive (when USB inserted)
- Aux-in
- BT MUSIC
- Long press to disconnect /reconnect
5. - Radio band switch
- Dial/Receive call
- Long press to re-dial.
- While talking, press to transfer the call.
6. - Number 1~6 (Keypad)
7. - Radio preset scan
- Radio auto preset(long press)
- MP3/WMA search
- Call off / cancel
8. - Display switch
- Time adjust (long press)
9. Radio tune
- Track skip/seek
10. - Aux-in jack
11. - USB connector
12. - Panel open
13. - Press to enter RDS PTY mode and use number button 1~6 to select RDS PTY stations.
14. - Press to turn RDS AF on/off.
- Long press to turn RDS TA on/off.
15. - Remote sensor

Panel Controls (Keypad)

Radio preset

Press each number button 1 ~ 6 more than 2 seconds to store current station, press briefly to recall stored station.

Disc playback

Press number button 1 to pause, press again to resume play.

Press number button 2 to intro play track on the disc for 10 seconds each, press again to intro play track in current folder for 10 seconds each, press again to end scan and play the selected track.

Press number button 3 to repeatedly play the current track, press again to repeatedly play all tracks in current folder, press again to resume normal play.

Press number button 4 to randomly play the current track, press again to randomly play all tracks in current folder, press again to resume normal play.

Press number button 5 or 6 to previous or next folder. (if there are more than 1 folders)
Press and hold 5 or 6 more than 2 seconds to goto -10 down or +10 up track.

Panel Controls (Other Instructions)

Press the  button to open the panel and press  to eject the disc.

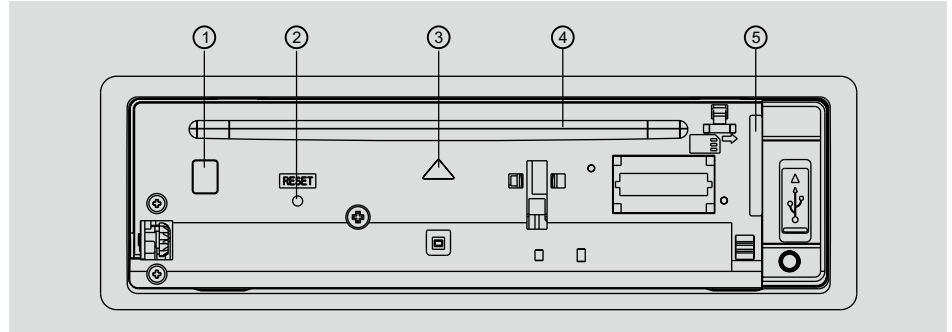

1. Disc eject (if there is a disc in the unit)
2. Reset hole (Note: Pressing the RESET hole will erase the clock setting and stored stations.)
3. Panel status indication: Lights up when you flip down the panel; twinkles when you remove the panel.
4. Slot, Insert the disc
5. SD/MMC card slot

REMOTE CONTROLS

Operating range

Point the remote control unit to the remote sensor when you operate with it. The remote control can operate within a distance of 3~5m.

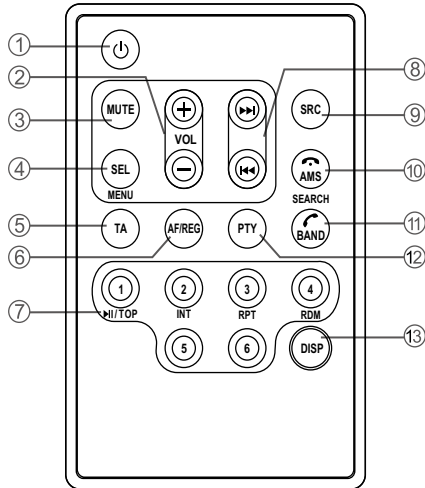
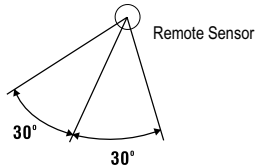

1. - Power on/off
2. - Volume
3. - Mute
4. - Press to select VOL/BAS/TRE/BAL/FAD, use volume button to adjust level.
- Press and hold it to enter Menu mode.
5. - Traffic announcements identification
6. - Alternative frequency
7. - REG on/off (long press)
8. - Disc Playback
Button 1: - Play/Pause
- Top play (press more than 2 sec)
Button 2: - Intro play (10 sec)
Button 3: - Track repeat play
Button 4: - Track random play
Button 5: - MP3 folder down
- Track -10 down
Button 6: - MP3 folder up
- Track +10 up
9. - Radio Preset
Press to listen to a preset station.
Press and hold to store station.
10. - AMS: Radio preset scan/Radio auto preset
- SEARCH: MP3 track/file/character search
- Call off / cancel
11. - Radio band switch
- Dial/Receive call
- Long press to re-dial.
- While talking, press to transfer the call.
12. - Program type
13. - Display switch

Replacing the lithium battery of remote control unit.

When the range of the operation of the card remote control becomes short or no functions while operating. Replace the battery with a new lithium battery. Make sure the battery Polarity replacement is correct.

1. Pull out the battery holder while pressing the stopper.
2. Insert the button-type battery with the stamped(+) mark facing upward. Insert the battery holder into the remote control.

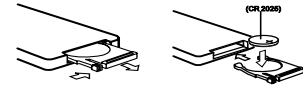

WARNING:

- Store the battery in place where children cannot reach. If a child accidentally swallowed the battery, consult a doctor immediately.
- Do not recharge, short, disassemble or heat the battery or dispose it in a fire. Doing this may cause the battery to give off heat, crack or start a fire.
- Do not leave the battery with other metallic materials or poke the battery with tweezers or similar tools.
- When throwing away or saving the battery, wrap it in tape and insulate.

General Operation

Power On/Off Button

Press the PWR button to turn the unit on when the vehicle ignition switch is on. Long press to turn the unit off.

Adjust Volume level



Rotate the VOL knob to adjust volume level. Rotate it clockwise to increase and anticlockwise to decrease the volume.

Mode Button (SRC)

Press the SRC button to change between Radio, DISC (when disc is in), USB (when USB connected), SD/MMC card (when card inserted), AUX play or BT audio.

Disc Load/Eject

Load: Press  to flip down the panel. Insert the disc into the slot .

Eject: Press  to flip down the panel. Press  to eject the disc .

Auxiliary Input (optional)

To access an auxiliary device:

1. Connect the portable audio player to the AUX interface.
2. Press the SRC button to select Aux-In mode.
3. Press SRC again to cancel Aux-In mode and go to the next mode.

Display Selector (DISP)

This unit can display either the clock time or radio frequency/CD player functions. Ordinarily, the radio frequency or CD player track indication is displayed, but the unit will display the time when the DISP button is pressed. The time will display for approximately 5 seconds then return to the radio or CD player function display.

Setting the Clock

The correct time of day can be set by pressing and holding the DISP button.

To set the clock, perform the following steps:

1. Turn the vehicle ignition and radio on.
2. Press the DISP button to view the clock.
3. With the clock visible on the display, press and hold the DISP button until the time display flashes.
4. Within 5 seconds, rotate the VOL knob counter clockwise to adjust the minutes to the desired setting. To change the hour, rotate the VOL knob clockwise to adjust the hour to the desired time.
5. Press DISP button to confirm and exit clock setting.

Radio Operation

Band Switch

Press BAND button to select radio band as follows: FM1, FM2, FM3, AM1, AM2

TUNE

MANU SEEK: Press  or  to tune step by step.

AUTO SEEK: Press  or  more than 2 seconds to seek automatically.

Store Station Manually

Press button 1 - 6 more than 2 seconds to store current station.

Press 1-6 briefly to recall preset station.

Store Station Automatically

Press AMS button more than 2 seconds to seek and save the 10 strongest stations in current band automatically.

Press AMS button briefly to intro play the preset stations.

Radio Operation

RDS service availability varies with areas. Please understand if RDS service is not available in your area, the following service is not available.

RDS Basics

AF(Alternative Frequency): When the radio signal strength is poor, enabling the AF function will allow the unit to automatically search another station with the same PI (program identification) as the current station but with stronger signal strength.

PS (Program Service name): The name of station will be display instead of frequency.

AF Mode:

AF on: AF function is activated.

AF off: AF function is disabled.

Remark: AF indicator on LCD will flash until RDS information is received. If RDS service is not available in your area, turn off the AF mode.

REG Mode: Press AF on the remote control for more than 2 seconds to switch REG mode on and off.

REG on: AF function will implement the regional code (of the PI) and only stations in the current region can be tuned automatically.

REG off: AF function will ignore the regional code (of the PI) and stations in the other regions can also be tuned automatically.

Traffic Announcements

Some RDS FM stations periodically provide traffic information.

TP (Traffic Program Identification)

Broadcasting of traffic information

TA (Traffic Announcements Identification)

Radio announcements on traffic conditions

TA Mode: Hold TA/AF button on the panel or press TA button on the remote control to turn on/off TA mode. When TA mode is turned on, the TA indicator will blink.

When traffic announcement is received, the TA indicator will display. The unit will temporarily switch to the tuner mode (regardless of the current mode) and begin broadcasting the announcement at TA volume level. After the traffic announcement is over, it will return to the previous mode and volume level. When TA is turned on, SEEK, SCAN, AMS function can only be received or saved when traffic program identification (TP) code is received.

EON (Enhanced Other Networks)

When EON data is received, the EON indicator lights and the TA and AF functions are enhanced.

TA: Traffic information can be received from the current station or stations in other network.

AF: The frequency list of preset RDS stations

is updated by EON data. EON enables the radio to make fuller use of RDS information. It constantly updates the AF list of preset stations, including the one that currently tuned into. If you preset a station around the area at your home, you will later be able to receive the same station at an alternative frequency, or any other station serving the same program, EON also keeps track of locally available TP stations for quick reception.

PTY Reception (Program Type)

RDS FM stations provide a program type identification signal.

Example: news, rock, info, sport, etc.

PTY Mode: Press PTY button to enter the MUSIC type, the previous type is shown. Press PTY again to enter SPEECH type. At MUSIC type or SPEECH type, use buttons 1 - 6 to select the desired program type. The selected PTY type is shown and searching starts if no other function is selected for 2 seconds. If there is no corresponding program type, NO PTY is shown and the unit will return to normal mode.

USB/SD/MMC Operation

1. Loading SD/MMC card
Press  button to open the panel, insert an SD/MMC card into the slot, with the front side at left. The unit will play the music automatically.
2. Taking out SD/MMC card
Push SRC button and switch to non CARD mode, slightly press SD/MMC card, take out the card after it popped out.
3. Loading USB equipment
Open the cap, insert the USB into the connector and the unit play the music in the USB storer automatically.
4. Taking out USB equipment
Push the SRC button and switch to non USB mode, then take off the USB storer, close the rubber cap.

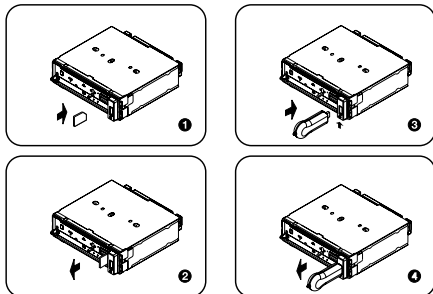

USB/SD/MMC Notes



USB functions (flash memory type) MP3 music play

1. SD/MMC card support.
2. USB flash memory 2 in 1 (SD/MMC) support.
3. Fat 12/fat 16/fat 32 is possible.
4. File name : 32 byte/dir name : 32 byte/tag name : 32 byte
5. Tag (ID3 tag ver 2.0)
- title/artist/album : 32 byte support.
6. Multi card reader not support.
7. USB 1.1/2.0 support (It can not support USB 2.0 speed. Just, get the same speed with USB 1.1).



Not all kinds of USB devices are compatible with the unit.

MP3/WMA Playback

Pause

Press the pause  button to suspend play.
Press the  button again to resume play.

Track Select

Press the  or  for less than one second to advance to the previous/next track, or for more than 2 seconds to fast forward or fast reverse through the track. Playback begins when the button is released.

Intro Scan (INT)

- Press the INT button once to select INT ON and play the first 10 seconds of each track.
- Press INT again to select "INT FOLD" and play the first 10 seconds of each track in the current folder.
- To turn off intro scan and play the current track, press the INT button again.

Repeat (RPT)

- Press the RPT button once to select RPT ON and repeatedly play the current file.
- Press RPT again to select RPT FOLD and repeatedly play all files in the current folder.
- To turn off repeat play, press the RPT button again.

MP3/WMA Playback

Random (RDM)

- Press the RDM button once to select RDM ON and randomly play all files on the source.
- Press RDM again to select RDM FOLD and randomly play all files in the current folder.
- To turn off random play, press the RDM button again.

MP3 Track Search

- Press AMS button to select the "TRK SCH" mode.
- Press MENU button and LCD display will show "TRK 001".
- Rotate the VOL knob to select the first digit and press MENU button to confirm.
- Rotate the VOL knob to select the tenth digit and press the MENU button to confirm.
- Rotate the VOL knob to select the hundredth digit and press the MENU button to confirm and play the track.

MP3 File Search

- Press AMS button twice to select the "FILE SCH" mode.
- Press MENU button to enter.
- Rotate the VOL knob to select the desired directory/song.
- Press MENU button to view the files inside the selected directory.

- Rotate the VOL knob to select the song/file. Press MENU button to play the selected song/file.

MP3 Character Search

- Press AMS button three times to select the "CHAR SCH" mode.
- Press MENU button and "A" display.
- If you want to select a track name beginning with a different letter, rotate the knob to select a letter, then press MENU button to confirm. Then "A" flashes at the next place, select 2nd and other character of the desired track name as steps above.
- Press MENU button more than 2 seconds to play your desired track.

MP3 Overview

- MP3 is short for MPEG Audio Layer 3 and refers to an audio compression technology standard.
- This product allows playback of MP3 files on CD-R or CD-RW discs.
- The unit can read MP3 files written in the format compliant with ISO 9660. However it does not support the MP3 data written by the method of packet write.
- The unit can not read an MP3 file that has a file extension other than ".mp3".
- If you play a non-MP3 file that has the ".mp3" extension, you may hear some noise.

- In this manual, we refer to what are called "MP3 file" and "folder" in PC terminology as "Track" and "Album", respectively.
- Maximum number of directory level is 8, including the root directory. Maximum number of files and folders per disc is 256.
- The unit may not play tracks in the order of track numbers.
- The unit plays only the audio tracks if a disc contains both audio tracks and MP3 files.
- When playing a disc of 8kbps or VBR*, the elapsed playing time in the display window will not be correct and also the intro play may not function properly.
*VBR: Variable Bit Rate.

Note on creating your own CD-Rs or CD-RWs containing MP3 files

- To enjoy high quality sound, we recommend converting to MP3 files with a sampling frequency of 44.1 kHz and a fixed bit rate of 128 kbps.
- DO NOT store more than 256 MP3 files per disc.
- For ISO 9660-compliant format, the maximum allowable depth of nested folders is 8, including the root directory(folder).
- When CD-R disc is used, playback is possible only for discs which have been finalized.

MP3/WMA Playback

- Make sure that when MP3 CD-R is burned that it is formatted as a data disc and NOT as an audio disc.
- You should not write non-MP3 files or unneeded folders along with MP3 files on the CD-R otherwise it takes a long time until the unit starts to play MP3 files.
- With some CD-R media, data may not be properly written depending on their manufacturing quality. In this case, data may not be reproduced correctly. High quality CD-R disc is recommended.
- Up to 16 characters are displayed for the name of an Album or a Track. ID3 TAG version 1.x is required.
- Note that the unit may not play tracks in the order that you wrote them to the disc.

Bluetooth Operation

Note:

For your safety, avoid talking on the phone as much as possible while driving.

Bluetooth is a wireless transmission way for short distance. The built-in Bluetooth can connect with the mobile phones having Bluetooth function.

After connecting, you can control your mobile phone through the unit.

Pairing

Use this function to establish a connection between the unit and your mobile phone.

1. Turn on the unit.
2. Turn on Bluetooth function of your mobile phone, keep phone within 3 meters to the unit and start to search for Bluetooth devices.
3. After the name of the Bluetooth module "CMB747" appears on the pairing list of your mobile phone, select it. At this time, a pairing code is required. Enter the pairing code "0000", and the Bluetooth pairing will process automatically. Some mobile phones may instruct you to select connect or disconnect, please select connecting.

Exit Pair



After pair successfully, if you want to disconnect, press and hold SRC button to disconnect Bluetooth connection.

If you want to re-connect, press and hold SRC button.

Make a call

1. Press SRC button to select BT MUSIC mode.
2. Press  button.
3. Rotate the VOL knob to select from the following list:
DIAL NUM: dial number directly
DIALLED: dialed number
MISSED: missed call
RECEIVED: received call
ME PBK: Phone directory
SIM PBK: SIM directory
4. Press MENU button to confirm the selection.



To dial a number directly, select DIAL NUM.

1. Rotate the VOL knob to select phone number, press MENU button to confirm.
 - Press  button to delete a digit inputted.
 - Press  button to reset entered number.
2. Press  to dial out.

Bluetooth Operation

To use a number in call log or directory, select the option other than DIAL NUM.

Receive

1. After pair successfully, if there is a call incoming, the unit switch to BT mode automatically.
2. Press  button to receive.
3. Press  button to hang up.

Call Transfer

During talking, press  button to transfer audio from the unit to your mobile phone.

Note:

Some mobile phones will transfer audio from the unit to themselves once the incoming call is answered.

BT Audio

To listen to audio from a bluetooth device and control playback with the unit.

1. Press SRC button repeatedly to select BT MUSIC mode.
2. To play or pause, press 1 ( TOP).

Music Mode

A2DP

A2DP is short for Advanced Audio Distribution Profile. The mobile phones supporting this function can transmit stereo audio, whereas

the ones not supporting this function can transmit mono audio only.

AVRCP

AVRCP is short for Audio/Video Remote Control Profile. The mobile phones supporting this function can control the playback of a Bluetooth audio player.

General Notes for Bluetooth

1. For some types of mobile phones, during our test, after the mobile phones appear connection successful, the unit still appear waiting for pairing. At this time you must find the unit's Bluetooth module name "CMB747" on the pairing list on your mobile phone and select connecting in the submenu, then the unit will appear CONNECT. Otherwise, there is no voice coming out when communicating, though the mobile phone has already displayed CONNECT. Some mobile phones, when it play back A2DP, you must find the unit name in the phone's menu and reconnect (check your mobile phone whether has the A2DP & AVRCP functions).
2. When pairing, some types of mobile phone hint that how to operate, for example, when you make a phone call by the unit, if the mobile phone voice doesn't be transferred to the unit, no voice comes out.
3. Depending on the mobile phone, if private mode is selected, when you make a phone call by the unit, or receive, the voice would be transferred to the mobile phone. But sometime the Bluetooth maybe disconnect till the communication ends, then connects your mobile phone to the unit automatically. Some mobile phones maybe need pair again.
4. For mobile phone, the Bluetooth device name must be primary symbols or numbers. Otherwise, some unpredictable issues may occur during the Bluetooth devices connecting and making phone call.
5. After CONNECT, if no sound produced, please check whether the Bluetooth stereo audio on the phone switched ON.

Menu Function

Press the MENU button more than 2 seconds to enter menu mode, then each press changes the mode, rotate the VOL knob to adjust.

TA mode

Rotate the knob to choose TA ALARM or TA SEEK mode.

If the TA (traffic Announcements) is turned on and there is no traffic program identification code received in the specified time, no TA/TP will display and either TA ALARM or TA SEEK will be activated.

TA ALARM mode : Alarm is turned on.

TA SEEK mode: TA SEEK is automatically activated.

MASK mode

Rotate the knob to choose MASK DPI or MASK ALL mode.

In some cases, the AF function may be influenced by some interference, examples are signals with strong field but without the RDS data. For this reason, the unit has two options to avoid the above interference.

MASK DPI mode :

Only AF which has different program identification is masked.

MASK ALL mode :

The AF which has different program identification and NO RDS signal with high field strength is masked.

TA VOL

Rotate the knob to adjust TA volume.

RETUNE mode

RETUNE mode: Rotate the knob to choose RETUNE-S or RETUNE-L.

RETUNE-S or RETUNE-L is time length selection of TA SEEK retune interval.

RETUNE-S: short, TA SEEK retune interval is 45 seconds.

RETUNE-L: long, TA SEEK retune interval is 180 seconds.

Remark: RETUNE mode functions for TA during TA SEEK mode only.

DSP mode

Rotate the knob to choose DSP sound effect: POP - ROCK - CLASSIC - FLAT - DSP OFF

LOCAL/DX mode

Rotate the knob to choose tuner sensitivity local or distant.

BEEP ON/OFF mode

Rotate the knob to choose button beep sound on or off.

STEREO/MONO mode

Rotate the knob to choose FM stereo or mono.

VOL LAST/ADJUST mode

Press MENU button to choose VOL LAST, the turn-on volume level is the volume level of latest power off.

Rotate knob to choose VOL ADJ, then rotate the knob to set the turn-on volume level.

WOOF ON/OFF mode

Rotate the knob to choose Sub-woofer on or off.

LOUD mode

Rotate the knob to choose loudness on or off.

SEEK 1 / 2 mode

SEEK 1: Searching station will stop when the next station is received.

SEEK 2: Searching station will stop when ◀ or ▶ button is released and next station is received.

12/24 HOUR SET mode

Press MENU button to enter 12/24 hour set mode, rotate the knob to select 12 or 24 hour mode.

Electrical Connections

Wiring Diagram

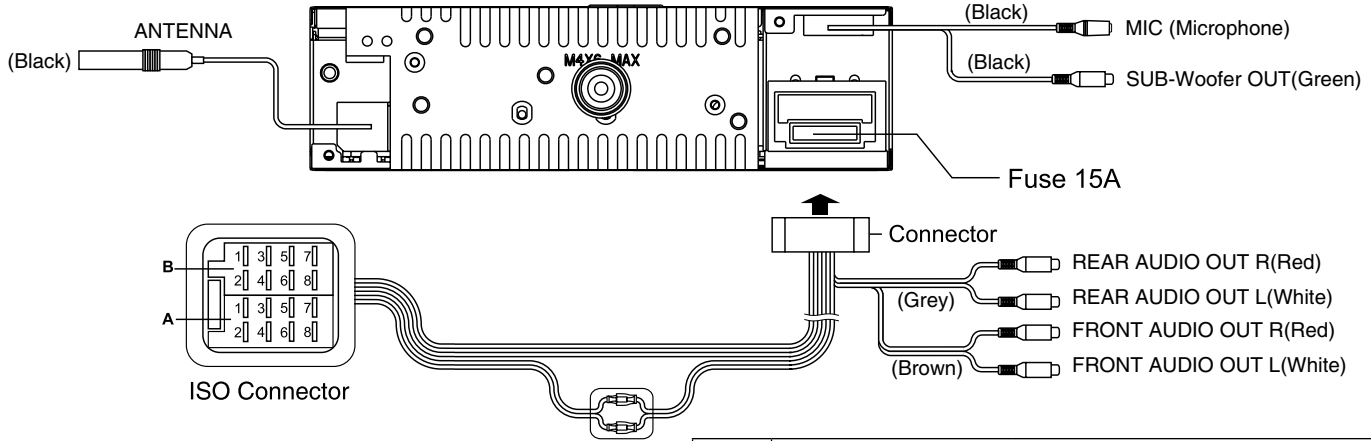

For some VW/Audi or Opel(Vauxhall) car models, you may need to modify wiring of the supplied power cord as illustrated, or else the memory of the unit may be lost after you power off. Contact your authorized car dealer before installing this unit.

Original wiring

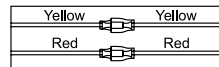

Modified wiring

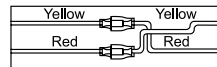

Location	Function	
	Connector A	Connector B
1		Rear Right (+) / Purple
2		Rear Right (-) / Purple with Black Stripe
3		Front Right (+) / Grey
4	Battery 12V(+) / Yellow	Front Right (-) / Grey with Black Stripe
5	ANT/AMP control / Blue with white stripe	Front Left(+) / White
6		Front Left(-) / White with Black Stripe
7	ACC+ / Red	Rear Left (+) / Green
8	Ground / Black	Rear Left (-) / Green with Black Stripe

Installation Guide

Installation Procedures

Carefully complete the electrical connections.
Check connections before operation.

Reset

Press “▲” to flip down the panel. Then press the “RESET” hole with a pointed object to reset the unit to restore the system to the original factory settings.

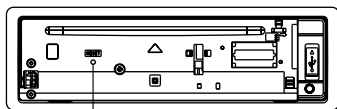

Reset

Installation Opening

This unit can be installed in any dashboard with a suitable 183 mm (W) x 52 mm (H) opening as shown below. The dashboard should be 4.75 mm - 5.56 mm thick in order to be able to support the unit.

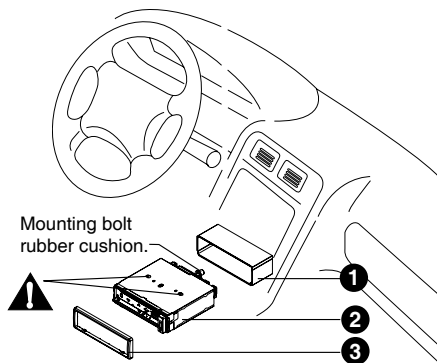
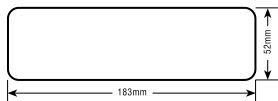

⚠ Important: Remove these two screws before installation. Otherwise, the player will not work.

- 1 Insert mounting collar into the dashboard, and bend the mounting tabs out with a screwdriver. Make sure that lock lever is flush with the mounting collar (not projecting outward).
- 2 Secure the rear of the unit.
After fixing mounting bolt and power connector, fix the rear of the unit to the car body by rubber cushion.
- 3 Insert trim plate.

Anti-Theft System

This unit is designed with a flip-down detachable panel.

The panel can be detached and taken with you, helping to deter theft.

Removing the panel

- Switch off the power of the unit.
- Press ▲ to flip down the panel.

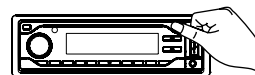

- Hold right side of the panel, slightly push it to the left side, then pull it out.

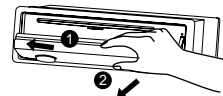

- Place the panel into the case and take it with you when you leave the car.

Anti-Theft System

Installing the panel

- Hold the panel and ensure the panel faces downward, and at an angle set one side of the panel in the panel bracket. Press the other side of the panel until it locks.

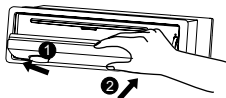

- Turn the panel from horizontal to vertical, push until it locks.

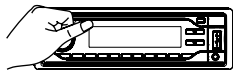

Removing the unit

- Remove the panel and the trim plate.
- Insert both T-Keys into holes on the front of the set until they lock.
- Pull out the unit.

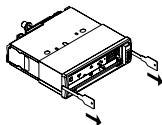

Troubleshooting

If you suspect something is wrong, immediately switch power off. Do not use the unit in abnormal condition, for example without sound, or with smoke or foul smell, can cause fire or electric shock. Immediately stop using it and call the store where you purchased it. Never try to repair the unit yourself because it is dangerous to do so.

General

No power or no sound.

Car's engine switch is not on.

Turn your car's key to ACC or ON.

Cable is not correctly connected.

Check connection.

Fuse is burnt. **Replace fuse.**

Check volume or mute on / off.

If the above solutions cannot help.

Press the RESET button.

Radio

Noise in broadcasts.

Station is too far, or signals are too weak.

Select other stations of higher signal level.

Preset station lost.

Battery cable is not correctly connected.

Connect the battery cable to the terminal that is always live.

Disc

Disc is inside but no sound.

Disc is upside down.

Place disc in the correct direction, and the label side up.

Disc is dirty or damaged.

Clean disc or change another disc.

Disc sound skips, tone quality is low.

Disc is dirty or damaged.

Clean CD or change another CD.

Sound skips due to vibration.

Mounting angle is over 30°.

Adjust mounting angle to less than 30°.

Unstable mounting.

Mount the unit securely with the mounting parts.

Specifications

General

Power supply:	12V DC (11V-16V) Test voltage 14.4V, negative ground
Maximum power output:	45Wx4 channels
Suitable speaker impedance:	4-8 ohm
Suitable speaker power:	80-100 Wx4 channels
Pre-Amp output voltage:	2.0V(CD play mode: 1KHz, 0 dB, 10 K Ω load)
Fuse:	15A
Weight:	1.64kg
Dimensions(WxHxD):	178x50x166mm
Sub-out(optional):	2.0V
Aux-in(optional):	\geq 300mV

FM Stereo Radio

Frequency range:	87.5-108.0MHz (EUR) 87.5-107.9MHz (USA)
Usable sensitivity:	10dB μ
Frequency response:	30Hz-15kHz
Stereo separation:	30dB(1 kHz)
Image response ratio:	50dB
IF response ratio:	70dB
Signal/noise ratio:	55dB

AM(MW) Radio

Frequency range:	522-1620KHz (EUR) 530-1710KHz (USA)
Usable sensitivity(S/N=20dB):	30dB μ

Disc Player

System:	Disc digital audio system
Frequency response:	20Hz-20kHz
Signal/noise ratio:	>75dB
Total harmonic distortion:	Less than 0.20%(1 KHz)
Channel separation:	>60dB
ESP mode:	CD \geq 12s, MP3 \geq 90s

Components

Mounting collar	1
Machine screws M5x6 mm	4
Mounting bolt (50 mm)	1
Wire connector	1
Case for removable control panel	1
Trim plate	1
T-key	2
Rubber cushion	1
Remote Control	1
External microphone	1

Note: Specifications and the design are subject to change without notice due to improvements in technology.

